

Article number: 439500085  
 Description: Rota-fix shaft-hub connection F85x125  
 Steel  
 Note: Self centering. Very high torque

## Measures

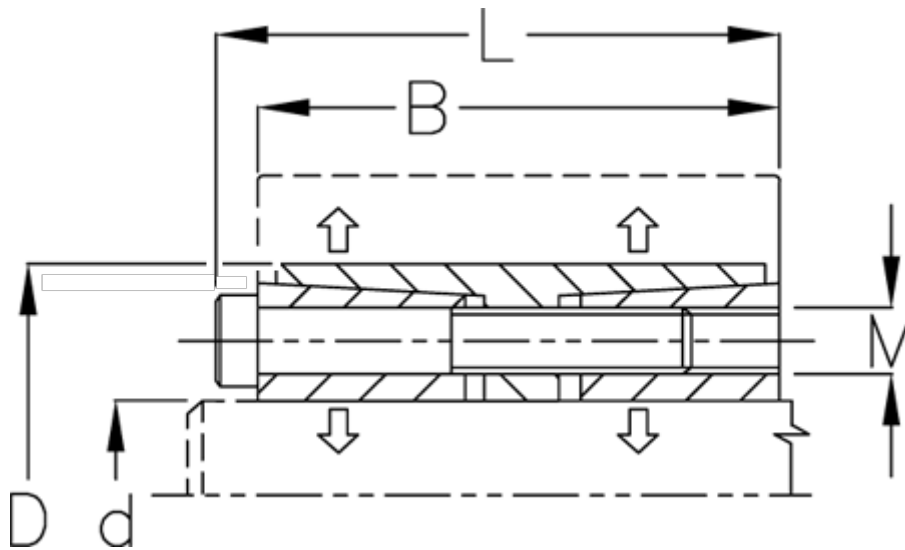

B mm	= 76
d H8 mm	= 85
D mm	= 125
Fit tolerance	= Aksel h8, Nav H8
F kN torque	= 340.0
L mm	= 86
M mm	= M10
P N/mm <sup>2</sup> surface pressure on shaft/hub	= 110

Surface roughness	= R? ? 3.2 µm
T N m torque	= 15000
Ts N m bolt tightening torque	= 83.0